

CATALOG #	TYPE	FRAME	OUTPUT		POLE	SYN. SPEED R.P.M.	VOLTAGE V.	Hz.	TIME RATING	INSULATION CLASS	SERVICE FACTOR	BEARINGS		WEIGHT LBS
			HP	KW								DE	NDE	
PG4006	AMHG	5009C	400	298.3	6	1200	2300/4160	60	CONT.	F	1.15	NU324C3	6320	3850

WEATHER PROTECTED TYPE I. SQUIRREL CAGE ROTOR

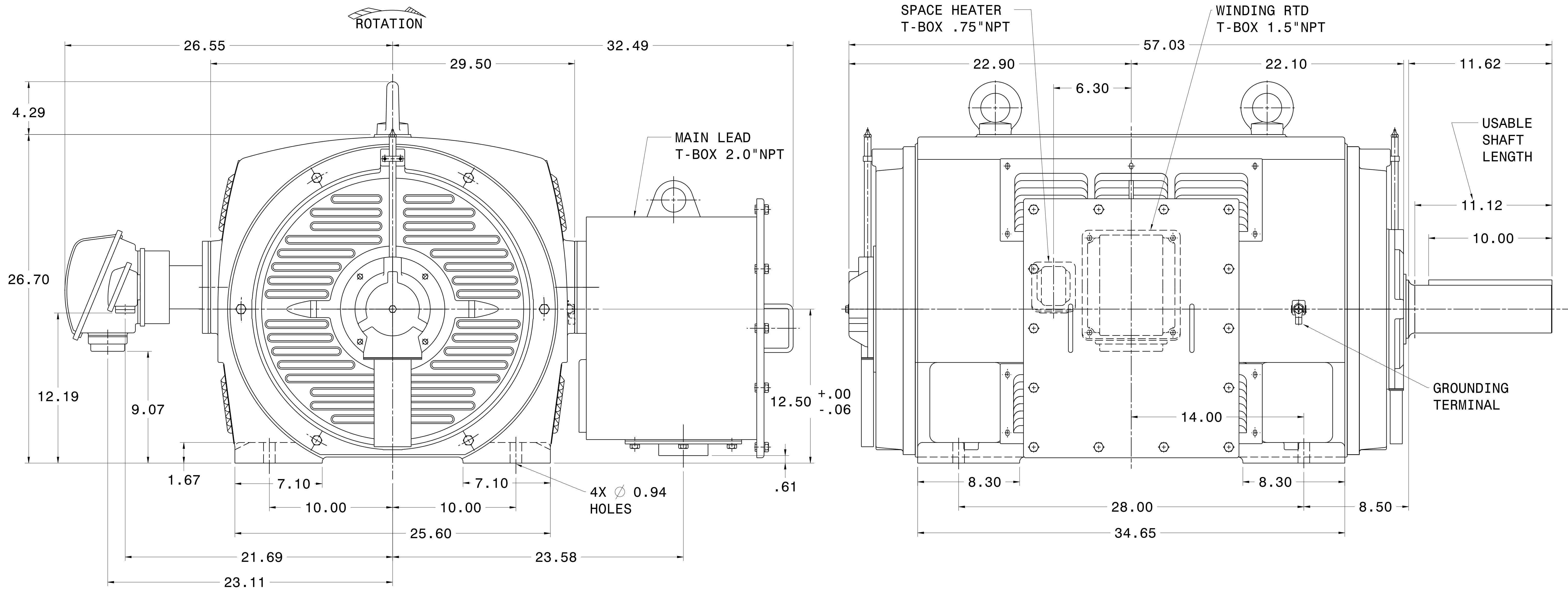

NOTES:

1. DIMENSIONS IN INCH.
2. ENCLOSURE: IP23.
3. FOR BELT DRIVE.
4. SPACE HEATER RATED 120 VOLT, SINGLE PHASE.
5. 100 OHM PLATINUM WINDING RTD'S, 2 PER PHASE.
6. PROVISION FOR BEARING RTD MOUNTING: 2X .50" NPT PER BRACKET.

REF: 4B040L319	REV. DATA	TECO Westinghouse		REV NO	01
	3-PHASE INDUCTION MOTOR OUTLINE DIMENSIONS			DWG NO.	PG4006
	DWN K. MILNER		080817	APPD T. FELPS	080817
	TECO-WESTINGHOUSE MOTOR COMPANY			ROUND ROCK, TEXAS	USA